

Stormwater Management Guidance for Single Family Residences

The City of Gresham has requirements designed to protect our local streams and groundwater from impacts that can be caused during and after construction activities. This document is designed to provide a concise overview of the requirements for single family residential projects.

Why manage stormwater?

Stormwater and stream samples across the state demonstrate that there is too much pollution and erosive velocity in streams. This is largely caused by runoff from impervious areas – surfaces that prohibit water from infiltrating into the soil, such as streets, sidewalks, roofs, driveways, patios, etc.

To protect Oregon’s resources for future generations, our goal is to put as much stormwater back into the ground using infiltration whenever possible. The use of plants in stormwater planters and ecoroofs helps evapotranspire water and provides habitat and the use of porous pavement and other BMPs helps soak water back into the soil.

Before you finalize your plans

As part of your site and project plans incorporate the following to maximize your credits:

- Minimize impervious area (IA). Limit driveway size and other IA. This reduces SDCs and future stormwater rates.
- Use impervious area reduction methods. Porous pavements and ecoroofs are not considered as impervious area, so including them in your design will reduce your SDC and future monthly stormwater rate.
- Integrate stormwater management. If you still have impervious surface requiring treatment after taking the above steps, determine where that treatment will occur, since it will likely affect your plumbing and grading plans.



What is required?

1. **Erosion Prevention and Sediment Control (EPSC)**. Erosion control permits are required for grading or building projects **disturbing 500 square feet** or more. Any activity that disturbs soil within the city requires erosion control. The city can enforce on any activity where dirt could potentially leave a site.
2. **Stormwater Management**. Stormwater management is required for any project **adding or replacing 1000 square feet** or more of impervious area.

Erosion Control Requirements

Erosion control is best accomplished by limiting disturbance to areas being activity constructed. Erosion can be prevented by keeping soil covered with vegetation, mulch, straw, rock or even plastic sheeting. Any inlets to the storm system on site need to be blocked, or have a catch basin insert installed.

The most commonly required erosion control practices are listed below. **Complete details on erosion control requirements can be found in the City's Erosion Prevention and Sediment Control (EPSC) Manual.**

Erosion Control Best Practices

Prevent erosion by retaining existing vegetation or adding mulch, straw, rock or plastic to areas with disturbed soils. **Perimeter control, inlet protection, and a construction entrance should all be added prior to any ground clearing or site disturbance.** An initial erosion control inspection (010) must be approved prior to approval of any construction activities.



1. Perimeter Control

The most commonly used perimeter control methods are silt fences (left photo) and straw wattles (right photo). Either method requires trenching and then using stakes to secure it.



2. Inlet Protection

Inlet protection filters must be installed on your site and downstream from active construction in the street. **Biobags are not allowed.**



3. Construction Entrance

Any construction site where vehicles or equipment will be driving on exposed soil need to install a rock entrance. The goal is to create an area for vehicles to enter and exit the site without tracking dirt into the street. Single family lots can install $\frac{3}{4}$ " rock in the same area where the driveway will eventually be located. The minimum depth of rock shall be 8", with a minimum length and width of 20' by 20'.



4. Material and Concrete Waste Management

Provide onsite locations for garbage management, concrete/paint washout. Store hazardous materials safely.



5. Sweep the street daily, or as dirt tracks

You are expected to keep the street in front of your job site clean on a daily basis.



Stormwater Management Methods

Stormwater management can be met by the following methods:

Method	Can be used to treat	Overview
Porous pavement	Driveway, patio, walkway	Pavers or porous concrete allow water landing on paved surfaces to infiltrate
Ecoroof	Roof	Roof constructed with layer of soil and plants that intercepts and filters rain
Stormwater Planter	Roof, driveway, patio, walkway	Concrete structure containing plants and soil to filter and/or infiltrate water piped to it
Rain Garden	Roof, driveway, patio, walkway	Shallow basin containing plants and soil to infiltrate or filter water piped to it
Soakage trench or Infiltration Vault	Roof, driveway, patio, walkway	Underground trench filled with rock designed to infiltrate water piped to it
Drywell	Roof, driveway, patio, walkway	Underground chamber that stores water and slowly releases it to surrounding rock and soil

More than one method can be used to treat different areas of a single project site. Details about each of these methods, as well as the sizing requirements you will need to submit to demonstrate you have planned adequate stormwater management to meet the requirements, are below.

1. Porous/Pervious Pavement (concrete, asphalt, blocks)

Use of this technique will be given a 1:1 credit, meaning areas where porous pavements are used will not be counted towards your SDC fees or future rates. Additional flow may **NOT** be directed onto this surface to count as treatment

Location

Can be used on any external paved surface – driveways, walkways, patios. Porous pavements shall not be used in areas within the 100-year floodplain, or at slopes that exceed 5%.

Construction

There are many types of porous pavements, which range from porous concrete to concrete pavers with gaps or holes designed to allow water to pass through. Any proposed porous pavement must meet state and city building codes. Porous asphalt is typically not preferred, but will be reviewed by Stormwater staff if proposed by developer.

Underdrain: Areas which infiltrate at less than 0.5"/hour, or with a slope greater than 2%, may need an underdrain.

Safety overflow: A safety overflow is required to prevent ponding in the event the surface is clogged. The overflow may consist of an inlet drain, catch basin, curb opening, or other method to convey water to an approved disposal point.



Maintenance

The long term effectiveness of porous pavement system requires that the surface layer is kept clear of debris and sediment, which can cause clogging. Regular sweeping is general sufficient to keep water infiltrating through the porous surface.

2. Ecoroof

This technique will be given a 1:1 credit for impervious area reduction and will not count towards SDCs or future rates. No additional flow may be directed onto this surface to count as treatment. Ecoroofs have buyer selling qualities of a long-life span documented to be 30-50 years, insulation that reduces heating and air needs, and are beautiful amenities if planned with a sitting area, etc.

Location

Ecoroofs are installed in place of a standard roof on top of a house, garage or addition. Roofs being proposed for an ecoroof installation function best with lower slopes (maximum of 25% slope).

Construction

The roof must be designed to structurally support the added weight of an ecoroof. Generally, the roof must be able to support an additional 15 to 30 pounds per square foot of saturated weight,



which includes the vegetation and growing medium. There are companies that sell and/or install ecoroof materials which will meet the requirements for waterproofing, growing medium and vegetation.

Waterproofing and Root Barrier: The roof surface needs to be coated with a high-quality waterproofing material, such as modified asphalt, synthetic rubber or reinforced thermal plastic.

Growing Medium: A minimum of 4" of growing medium is required. The preferred blend for growing medium is 70% porous material, 20% organic material (e.g. compost), and 10% digested fiber.

Vegetation: Drought tolerant plants that are evergreen and require little or no irrigation after establishment work best. A mixture of sedum and succulent plants is the best way to achieve the desired plant community.

Maintenance

Plants may need to be watered during the first 2 years after installation, until they become established. Irrigation should be minimized and not exceed 0.5" of water every 10 days. Pesticides/herbicides should not be used, and if fertilizer use should be limited and only be from an organic source (fertilizer may cause nutrient export from the ecoroof into stormwater).

3. Stormwater Planter

Stormwater planters are structural reservoirs filled with soil and plants, designed to collect, filter and infiltrate stormwater (depending on location).

Location

Planters should be designed to infiltrate unless site is located 1) on fill, 2) steep slopes, or 3) in areas DEQ considers contaminated. Infiltration planters must be located 5 feet from property lines and 10 feet from building foundations. Lined/filtration planters can be located next to foundation walls, property lines, on slopes, fill or in contaminated soils.



Construction

Infiltration planters will have concrete walls, but open on bottom. Lined/filtration planters must be monolithically poured concrete without joints (all walls and bottom poured at same time), otherwise a 30-mil PVC liner must be installed inside. Pipe (cast iron, ABS or PVC) shall be installed as overflow, and a perforated underdrain pipe needs to be installed for lined/filtration planters. Lined and unlined facilities must have a minimum of 18" of 3-way soil planted with 1-gallon plants at 1-foot spacing. A layer of drain rock can be used in infiltration planters and must be used in lined/filtration planters (per detail ST-151).

Maintenance

Sediment, debris, and weeds should be removed every 6 months, or as needed. Vegetation may need to be watered during the first 2 years after installation, until it becomes established.

4. Rain Garden

Rain gardens are shallow depressions filled with soil and plants, designed to collect, filter and infiltrate stormwater (depending on location). **The City prefers planters over rain gardens.**



Location

Rain gardens should be designed to infiltrate unless site is located 1) on fill, 2) steep slopes, or 3) in areas DEQ considers contaminated. Infiltration rain gardens must be located 5 feet from property lines and 10 feet from building foundations. If a lined/filtration facility would be required, install a planter.

Construction

Infiltration rain gardens have gently sloped sides with a flat basin on the bottom. Lined/filtration rain gardens must have a 30-mil PVC liner under the soil and a layer of drain rock. Pipe (cast iron, ABS or PVC) shall be installed as overflow, and a perforated underdrain pipe needs to be installed for lined/filtration rain gardens. Lined and unlined facilities must have a minimum of 18" of 3-way soil planted with 1-gallon plants at 1-foot spacing. A layer of drain rock can be used in infiltration rain gardens and must be used in lined/filtration planters (per detail ST-141).

Maintenance

Sediment, debris, and weeds should be removed every 6 months, or as needed. Vegetation may need to be watered during the first 2 years after installation, until it becomes established.

5. Soakage Trench or Infiltration Vault

A soakage trench is a shallow trench filled with drain rock. A perforated pipe distributes stormwater to the trench, where it is stored before infiltrating into underlying soil. An infiltration vault is a trench containing drain rock that also has a larger horizontal perforated pipe within it to store water that will eventually infiltrate. Soakage trenches and infiltration vaults are classified as UICs by DEQ, and if anything except runoff from residential roofs drains to them, they must have pre-treatment and be registered with DEQ.



Location

Soakage trenches must be located 5 feet from property lines and 10 feet from building foundations. Soakage trenches should not be installed on slopes 20% or greater. There must be a 5-foot separation distance between bottom of trench to groundwater.

Construction

The trench should be a minimum of 30" deep and 30" wide, with the length being 20' (or 30' in soils draining <math><2''</math>/hour) for every 1,000 sq ft of impervious area draining to the soakage trench. The trench should be lined with permeable filter fabric prior to adding the drain rock, and then the filter fabric should be folded over the top of the trench after the perforated pipe has been installed. At least a foot of soil or drain rock should be placed over the top of the soakage trench, depending on whether lawn or a "dry riverbed" landscape is desired.

Maintenance

A sediment trap must be located upstream of the soakage trench to ensure that leaves and sediment don't clog it. The sediment trap should be inspected and cleaned once per year, or as needed.

6. Drywell

A drywell is an underground perforated plastic or concrete chamber surrounded by drain rock. Stormwater is temporarily stored in the drywell before it soaks into the surrounding soil. Drywells are classified as UICs by DEQ, and if anything except roof runoff from single family residential drains to them, they must have pre-treatment and then be registered with DEQ.

Location

Drywells must have a 5-foot separation distance between bottom of trench to groundwater. The center of the drywell must be located 5 feet from property lines and 10 feet from building foundations. The top of the drywell shall be located downslope from all foundations and should not be installed on slopes 20% or greater.

Construction

The drywell size should be selected based on the table on detail ST-170. The depth of the hole to be excavated needs to be at least 2' deeper than the depth listed in the table to account for 2' minimum fill on top of drywell, and the width of the hole should be at least 2' wider than listed to provide space for drain rock to be added around the drywell.

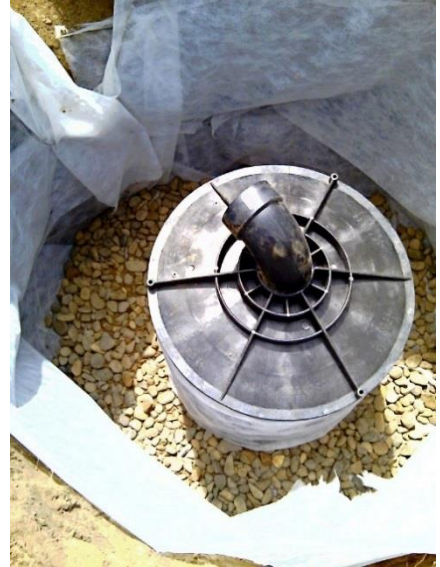

Maintenance

A sediment trap must be located upstream of the drywell to ensure that leaves and sediment don't clog it. The sediment trap should be inspected and cleaned once per year, or as needed.

Attachments

1. EPSC Plan for Single Family Residential/Duplex sites
2. Stormwater Facility Simple Sizing Form
3. Typical Stormwater Details
 - a. Porous pavement (ST-100)
 - b. Ecoroof (ST-110)
 - c. Rain Garden (infiltration option ST-140; filtration option ST-141)
 - d. Stormwater Planter (infiltration option ST-150; filtration option ST-151)
 - e. Drywell (ST-170)
 - f. Mini Drywell (ST-171)
 - g. Soakage Trench (ST-180)
 - h. Infiltration Vault (ST-190)

EPSC Plan for Single Family Residential/Duplex– City of Gresham

The following commitments constitute my Erosion Prevention and Sediment Control (EPSC) Plan as required under the City’s EPSC Manual. In developing this plan, I certify that I have evaluated site contours and drainage patterns, identified potential erosion and sediment problems, evaluated EPSC measures, and will implement EPSC measures prior to performing any earthwork or site grading. I will follow this plan and make ongoing revisions as needed to ensure sediment stays on site and other construction-related pollutants and debris are kept out of stormwater and other waters.

I further certify that all EPSC measures will be installed in accordance with City requirements including the City’s Stormwater Management Manual and EPSC Manual. I understand that the City will inspect my site for implementation of this EPSC Plan before and during construction, and that a stop-work order may be issued if I fail to properly implement EPSC measures.

	Responsibilities	Initial
1.	I understand I am responsible, as the permit holder, to keep sediment onsite.	
2.	I will provide a linear barrier (such as a sediment fence) and perimeter control where needed to keep sediment onsite.	
3.	I will ensure that construction debris, paint, concrete, and other pollutants are kept out of stormwater, streams, storm drains, and any stormwater treatment systems such as street raingardens.	
4.	I will provide storm drain inlet protection.	
5.	I will provide construction entrance/exit tracking controls.	
6.	I will provide concrete management.	
7.	I will provide slope breaks for steep slopes.	
8.	I will provide stockpile management for both soil stockpiles and non-soil stockpiles.	
9.	I will provide temporary ground cover (such as straw mulch) during October 1 – May 31, or until wet weather subsides, and permanent seeding and planting.	
10.	I will provide daily inspection and maintenance when work is ongoing, as needed during wet weather, and even if work is not ongoing to ensure this plan is met.	
11.	I will remove temporary erosion controls once construction is completed and the site is stabilized.	
12.	I understand the City may require modifications or additional EPSC measures to be installed onsite.	

Name: _____ Phone Number: _____

Full Construction Property Address: _____

Person Responsible for Implementing and Inspecting EPSC Measures: _____

Phone Number: _____

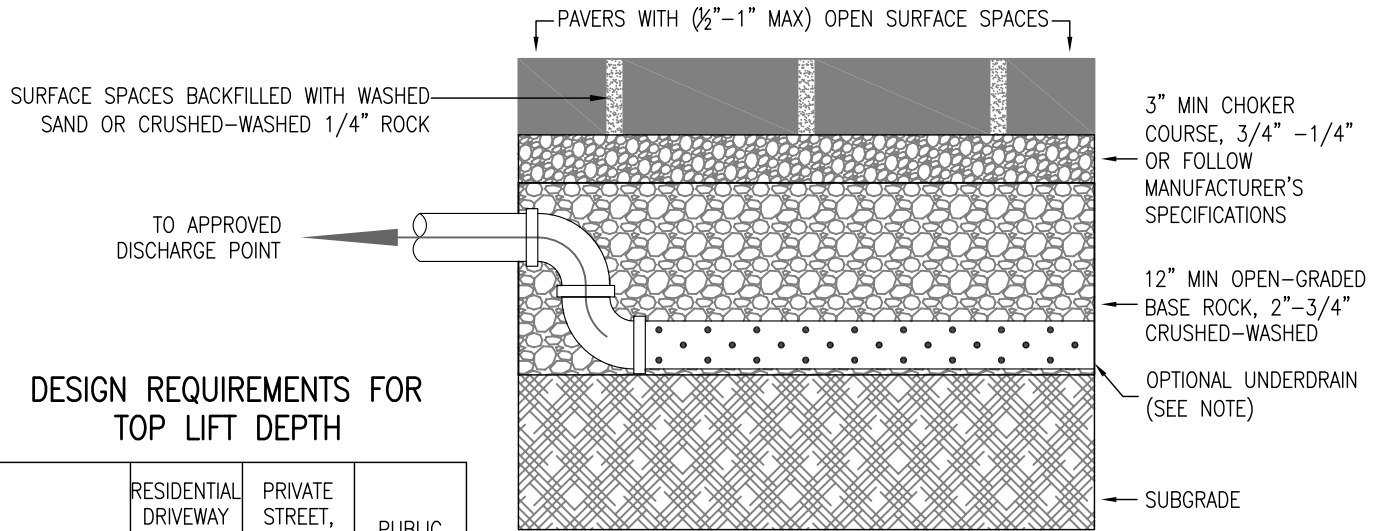

DESIGN REQUIREMENTS FOR TOP LIFT DEPTH

	RESIDENTIAL DRIVEWAY OR PEDESTRIAN ONLY	PRIVATE STREET, PARKING LOT, OR FIRE LANE	PUBLIC STREET
CONCRETE	4"	4"	7"
ASPHALT	2 1/2"	3"	6"
PAVERS	2 3/8"	3 1/8"	3 1/8"
ENGINEERING REQ'D	NO	YES	YES
COMPACTION REQ'D	NO	YES	95%

PERMEABLE CONCRETE BLOCK OR "PAVER" SYSTEMS

NOTE: 6" UNDERDRAIN REQUIRED FOR TYPE C AND TYPE D SOILS (<2"/HR INFILTRATION RATES)

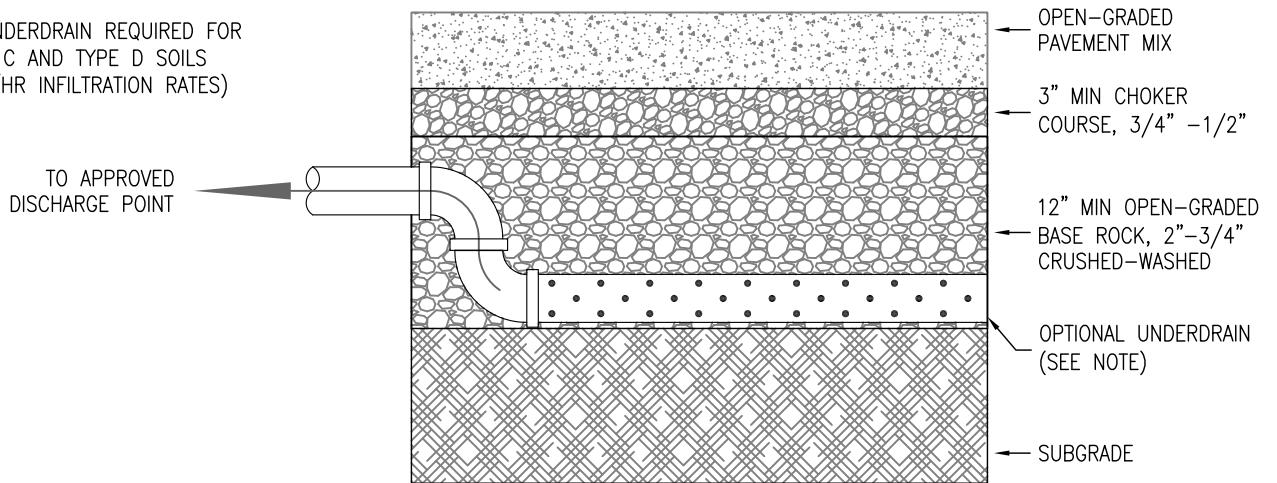

PERVIOUS (OPEN GRADED) CONCRETE AND ASPHALT SYSTEMS

- DRAWING NOT TO SCALE -

CITY OF GRESHAM	POROUS PAVEMENT	DRAWN RMS
		DATE APR 2018
		APPR.
		DWG. NO. ST-100

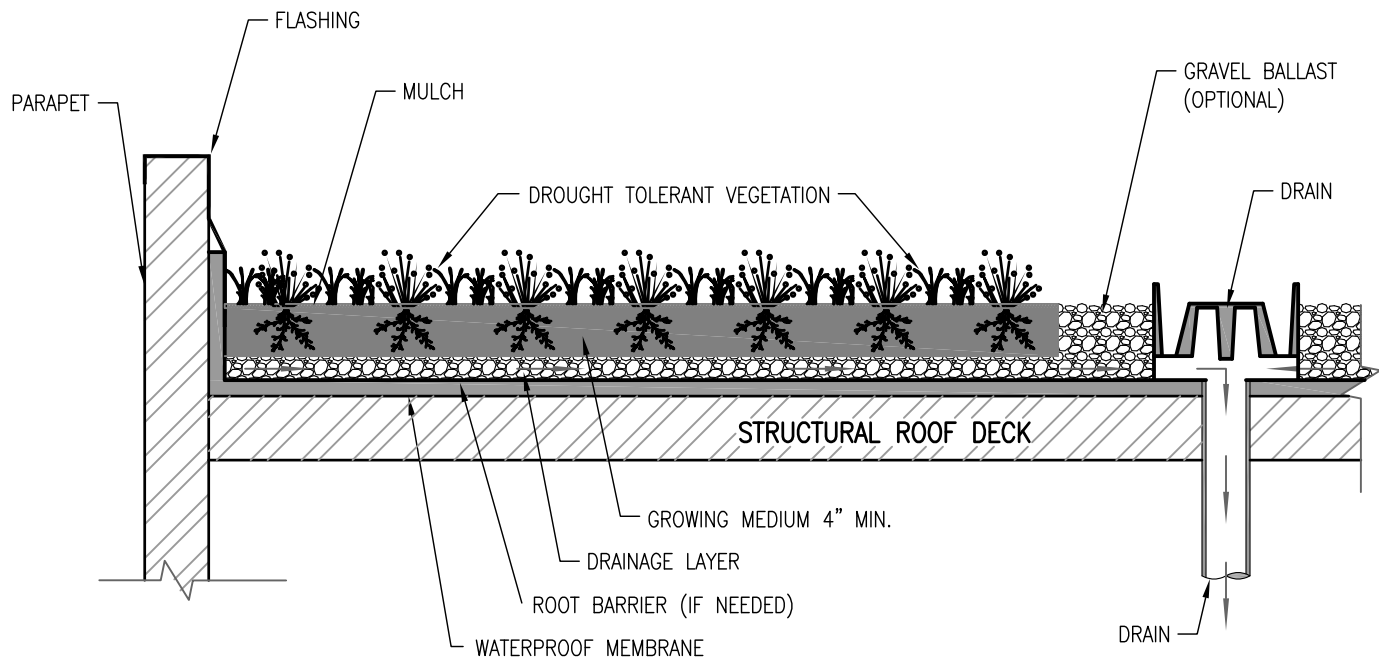

ECOROOF WITH DRAINAGE LAYER

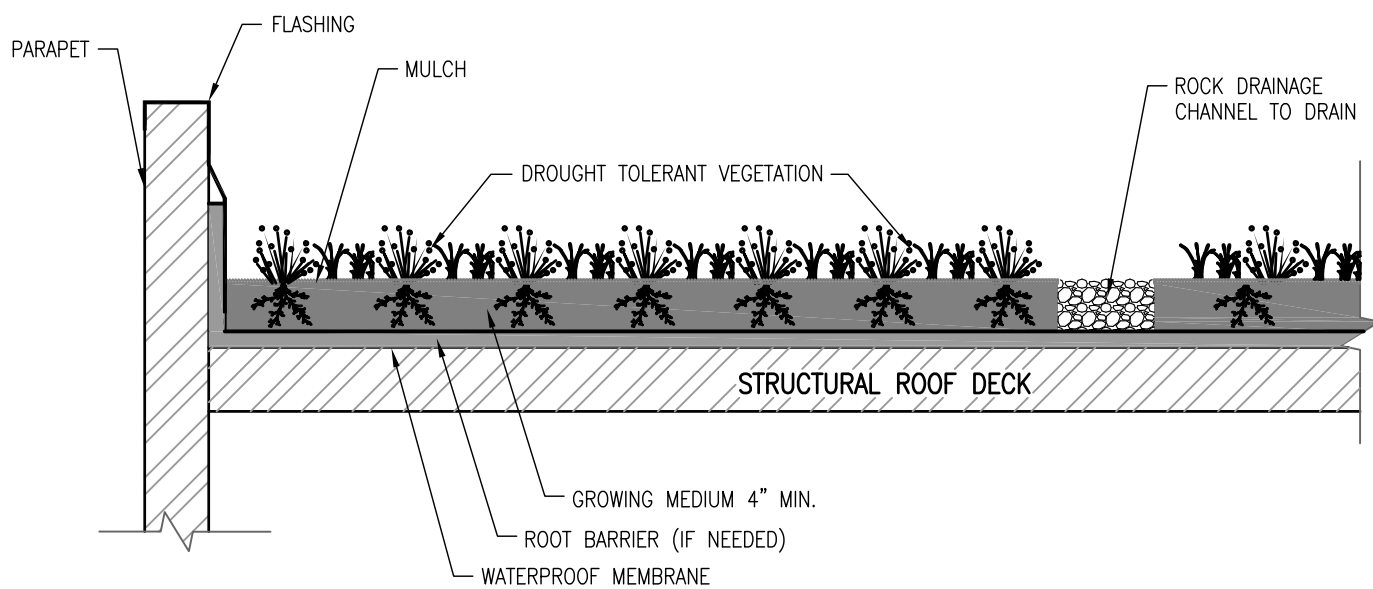

ECOROOF WITH DRAINAGE CHANNELS

CITY OF
GRESHAM

ECOROOF

DRAWN DRO

DATE APR 2018

APPR.

DWG. NO. ST-110

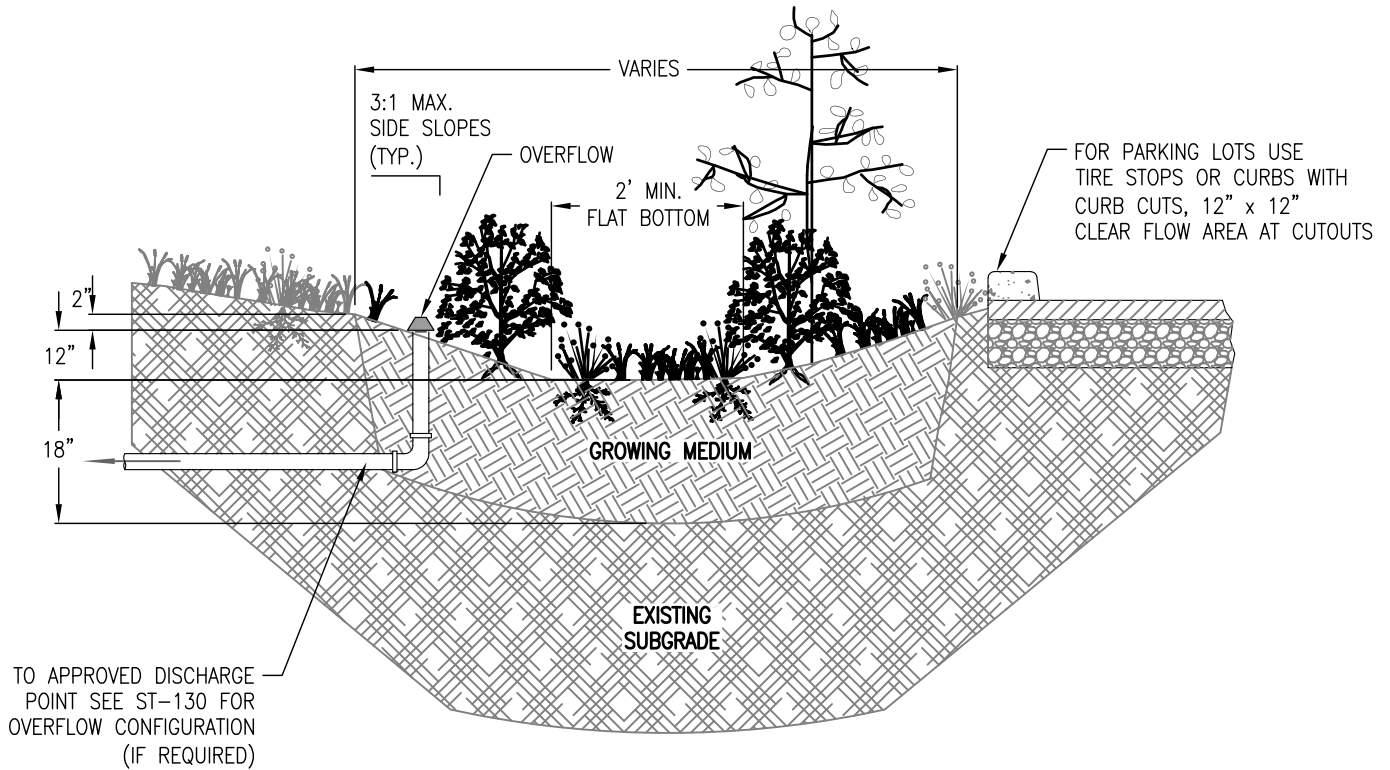

1. Provide protection from all vehicle traffic and equipment staging in proposed infiltration areas prior to, during, and after construction.
2. Dimensions:
Width and length vary. Dimensions to be specified on plans based on sizing form.
Depth (from top of growing medium to overflow elevation): 12".
Flat bottom width: 2' minimum.
Side slopes: 3:1 maximum.
3. Setbacks:
Facility should be 10' away from foundations and 5' away from property lines.
4. Overflow:
Facility must connect to approved discharge point per detail ST-130.
Overflow elevation must allow for 2" of freeboard, minimum.
Protect from debris and sediment with strainer or grate.
5. Piping must be cast iron, ABS or PVC. 3" pipe required for facilities draining up to 1500 s.f., otherwise 4" minimum pipe. Oregon Plumbing Specialty Code also applies.
6. Growing Medium:
18" minimum depth. Use sand/loam/compost 3-way mix, or approved mix that will support healthy plants.
7. Vegetation: Follow landscape plans otherwise refer to plant list in Appendix G. Minimum container size is #1. # of plantings per 100sf of facility area:
Zone A (wet): 80 herbaceous plants OR 72 herbaceous plants and 4 small shrubs.
Zone B (moderate to dry): 7 large or small shrubs AND 70 groundcover plants.
The delineation between Zone A and B must be either at the outlet elevation or the check dam elevation, whichever is lowest.
If facility area is over 200sf consider adding a tree.
8. Splash Block: Install 4-6" washed river rock or splash pad for erosion control at inlets and downspout.
9. Rain garden can be elongated to create a swale for larger developments. Slope should be 6% or less.

- DRAWING NOT TO SCALE -
ORIGINAL DRAWING AND SPECIFICATIONS FROM PORTLAND BUREAU OF ENVIRONMENTAL SERVICES

CITY OF GRESHAM	INFILTRATION RAIN GARDEN/SWALE	DRAWN DRO
		DATE OCT 2019
		APPR.
		DWG. NO. ST-140

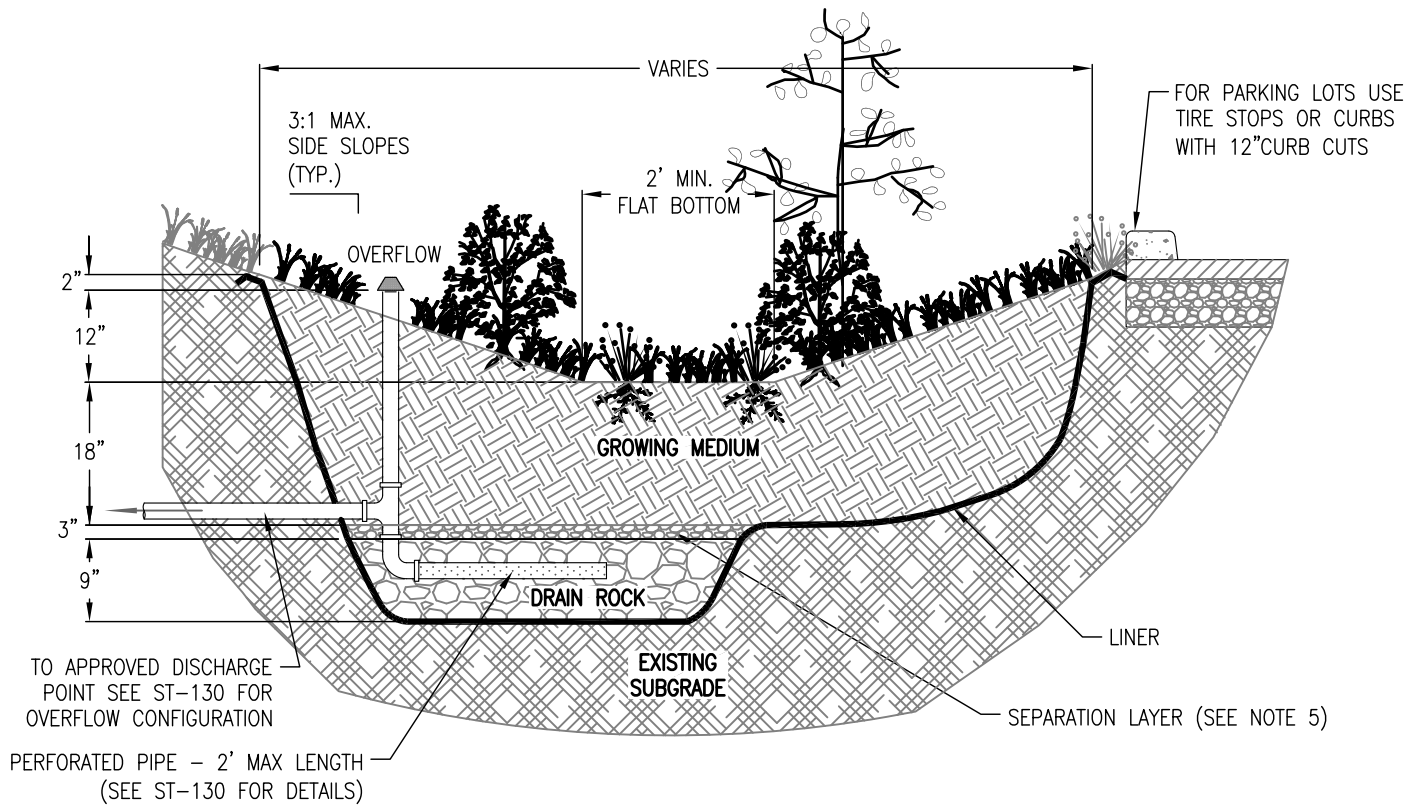

1. Dimensions:
 - Width and length vary. Dimensions to be specified on plans based on sizing form.
 - Depth (from top of growing medium to overflow elevation): 12".
 - Flat bottom width: 2' recommended.
 - Side slopes of swale: 3:1 maximum.
2. Setbacks: None required for lined facilities. Partial infiltration facilities should be 10' from foundations and 5' from property lines..
3. Overflow:
 - Facility must connect to approved discharge point per detail ST-130.
 - Overflow elevation must allow for 2" of freeboard, minimum.
 - Protect from debris and sediment with strainer or grate.
 - Overflow must have a 6"-12" upturn prior to discharge.
4. Piping must be cast iron, ABS or PVC. 3" pipe required for facilities draining up to 1500 s.f., otherwise 4" minimum pipe. Oregon Plumbing Specialty Code also applies.
5. Drain Layer:
 - Not allowed for type A and B soils (unless lined facility). Optional for type C soils, and required for type D soils.
 - 3/4"-1 1/2" washed round rock. Depth: 9".
 - Separation between drain rock and growing medium:
 - 1/4" - #10 rock, 2 to 3 inches deep.
6. Growing Medium:
 - 18" minimum depth. Use sand/loam/compost 3-way mix, or approved mix that will support healthy plants.
7. Vegetation: Follow landscape plans otherwise refer to plant list in Appendix G. Minimum container size is #1. # of plantings per 100sf of facility area:
 - Zone A (wet): 80 herbaceous plants OR 72 herbaceous plants and 4 small shrubs.
 - Zone B (moderate to dry): 7 large or small shrubs AND 70 groundcover plants.
 - The delineation between Zone A and B must be either at the outlet elevation or the check dam elevation, whichever is lowest.
 - If facility area is over 200sf consider adding a tree.
8. Waterproof Liner: 30 mil EPDM, HDPE or approved equivalent required for lined/filtration facilities per SWMM section 1.2.2.
9. Splash Block: Install 4-6" washed river rock or splash pad for erosion control at inlets and downspout.
10. Rain garden can be elongated to create a swale for larger developments. Slope should be 6% or less.

- DRAWING NOT TO SCALE -
ORIGINAL DRAWING AND SPECIFICATIONS FROM PORTLAND BUREAU OF ENVIRONMENTAL SERVICES

CITY OF GRESHAM	PARTIAL INFILTRATION - LINED/FILTRATION RAIN GARDEN/SWALE	DRAWN DRO
		DATE OCT 2019
		APPR.
		DWG. NO. ST-141

FREESTANDING

Design professional is responsible for verifying that grades will allow piped conveyance to facility.

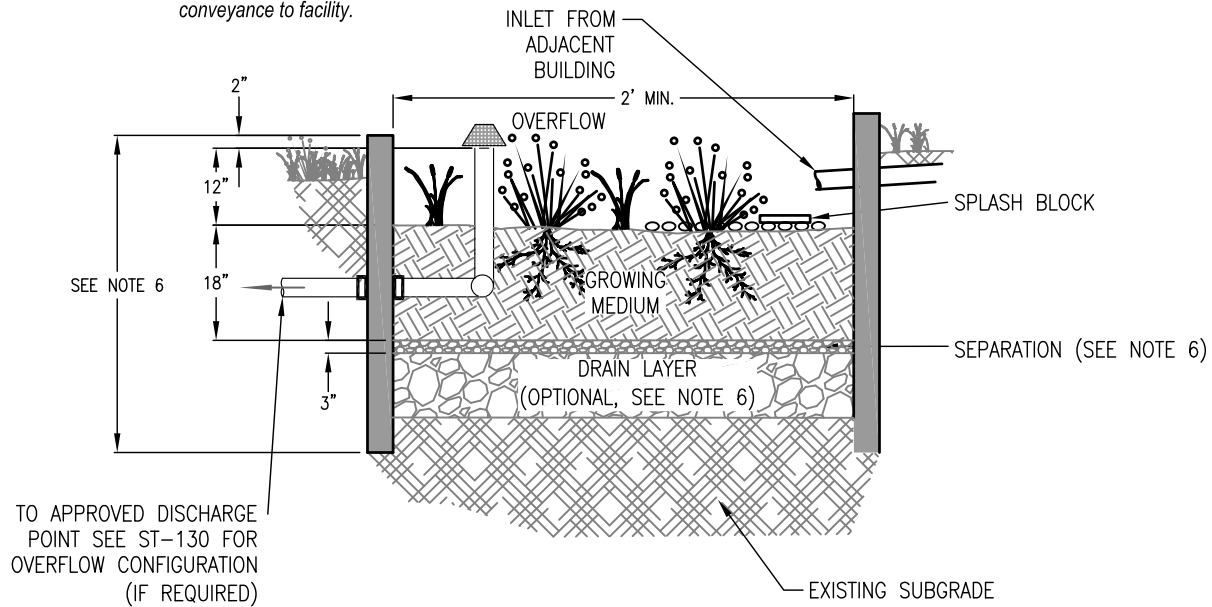

TO APPROVED DISCHARGE POINT SEE ST-130 FOR OVERFLOW CONFIGURATION (IF REQUIRED)

1. Provide protection from all vehicle traffic and equipment staging in proposed infiltration areas prior to, during, and after construction.
2. Dimensions:
Width of planter: 24" minimum.
Depth of planter (from top of growing medium to overflow elevation): 12".
Longitudinal slope of planter: 0.5% or less.
3. Setbacks:
Planters should be 5-feet from property line and 10-feet from building foundations.
4. Planter Walls:
Material must be concrete, unless otherwise approved. Walls must be included on foundation plans.
Height: 44" minimum with drain rock, 32" minimum without drain rock.
5. Piping must be cast iron, ABS or PVC. 3" pipe required for facilities draining up to 1500 s.f., otherwise 4" minimum pipe. Oregon Plumbing Specialty Code also applies.
6. Drain Layer:
Not allowed for type A and B soils, optional for type C soils, and required for type D soils.
3/4" - 1 1/2" washed.
Depth: 9".
7. Overflow:
Planters must connect to approved discharge point per detail ST-130.
Overflow elevation must allow for 2" of freeboard, minimum. Protect from debris and sediment with strainer or grate.
8. Growing Medium:
18" minimum depth. Use sand/loam/compost 3-way mix, or approved mix that will support healthy plants.
9. Vegetation: Refer to plant list in Appendix G. Minimum container size is #1. # of plantings per 100sf of facility area:
80 herbaceous plants OR;
72 herbaceous plants and 4 small shrubs.
10. Splash Block: Install 4-6" washed river rock or splash pad for erosion control at inlets and downspout.
11. Perforated pipe to be added for facilities in poorly infiltrating soils (Type D) per ST-130.
12. Lined/Filtration Planter to be used on steep slopes or within 10' of buildings.

Separation between drain rock and growing medium:
3/4" - #10 rock, 2 to 3 inches deep.

**- DRAWING NOT TO SCALE -
ORIGINAL DRAWING AND SPECIFICATIONS FROM PORTLAND BUREAU OF ENVIRONMENTAL SERVICES**

**CITY OF
GRESHAM**

INFILTRATION PLANTER

DRAWN DRO

DATE OCT 2019

APPR.

DWG. NO. ST-150

ADJACENT TO BUILDING

Design professional is responsible for verifying that grades will allow piped conveyance to facility.

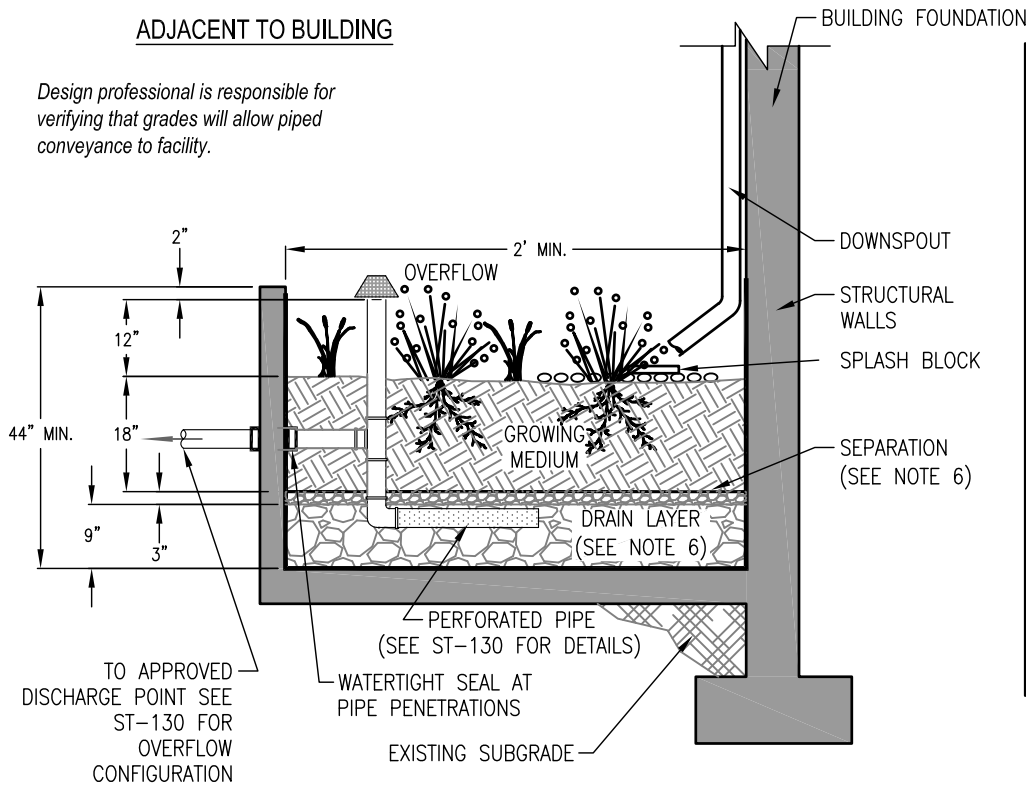

FREESTANDING PLANTER

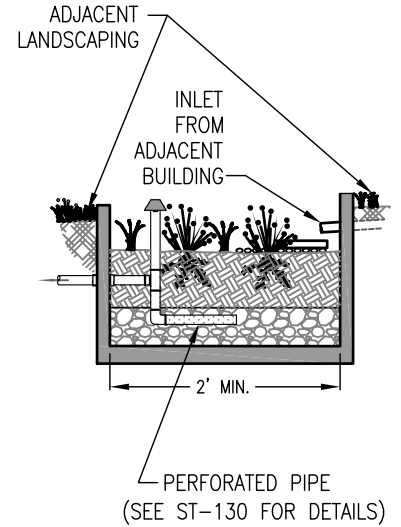

1. Dimensions:
Width of planter: 24" minimum.
Depth of planter (from top of growing medium to overflow elevation): 12".
Longitudinal slope of planter: 0.5% or less.
2. Setbacks:
Planters must be less than 30" in height above finish grade if within 5-feet of property line.
3. Planter Walls:
Material must be monolithically poured concrete. Walls must be included on foundation plans.
4. Waterproofing:
Monolithically poured planter, without joints is required. Check state structural requirements for foundations.
5. Piping must be cast iron, ABS or PVC. 3" pipe required for facilities draining up to 1500 s.f., otherwise 4" minimum pipe. Oregon Plumbing Specialty Code also applies.
6. Drain Layer:
3/4" - 1 1/2" washed round rock.
Depth: 9".
Separation between drain rock and growing medium:
1/4" - #10 rock, 2 to 3 inches deep.
7. Overflow:
Planters must connect to approved discharge point per detail ST-130. Overflow elevation must allow for 2" of freeboard, minimum. Protect from debris and sediment with strainer or grate.
8. Growing Medium:
18" minimum depth. Use sand/loam/compost 3-way mix, or approved mix that will support healthy plants.
9. Vegetation: Refer to plant list in Appendix G. Minimum container size is #1.
of plantings per 100sf of facility area:
80 herbaceous plants OR;
72 herbaceous plants and 4 small shrubs.
10. Splash Block: Install 4-6" washed river rock or splash pad for erosion control at inlets and downspout.

- DRAWING NOT TO SCALE - ORIGINAL DRAWING AND SPECIFICATIONS FROM PORTLAND BUREAU OF ENVIRONMENTAL SERVICES

CITY OF GRESHAM	FILTRATION PLANTER	DRAWN DRO
		DATE OCT 2019
		APPR.
		DWG. NO. ST-151

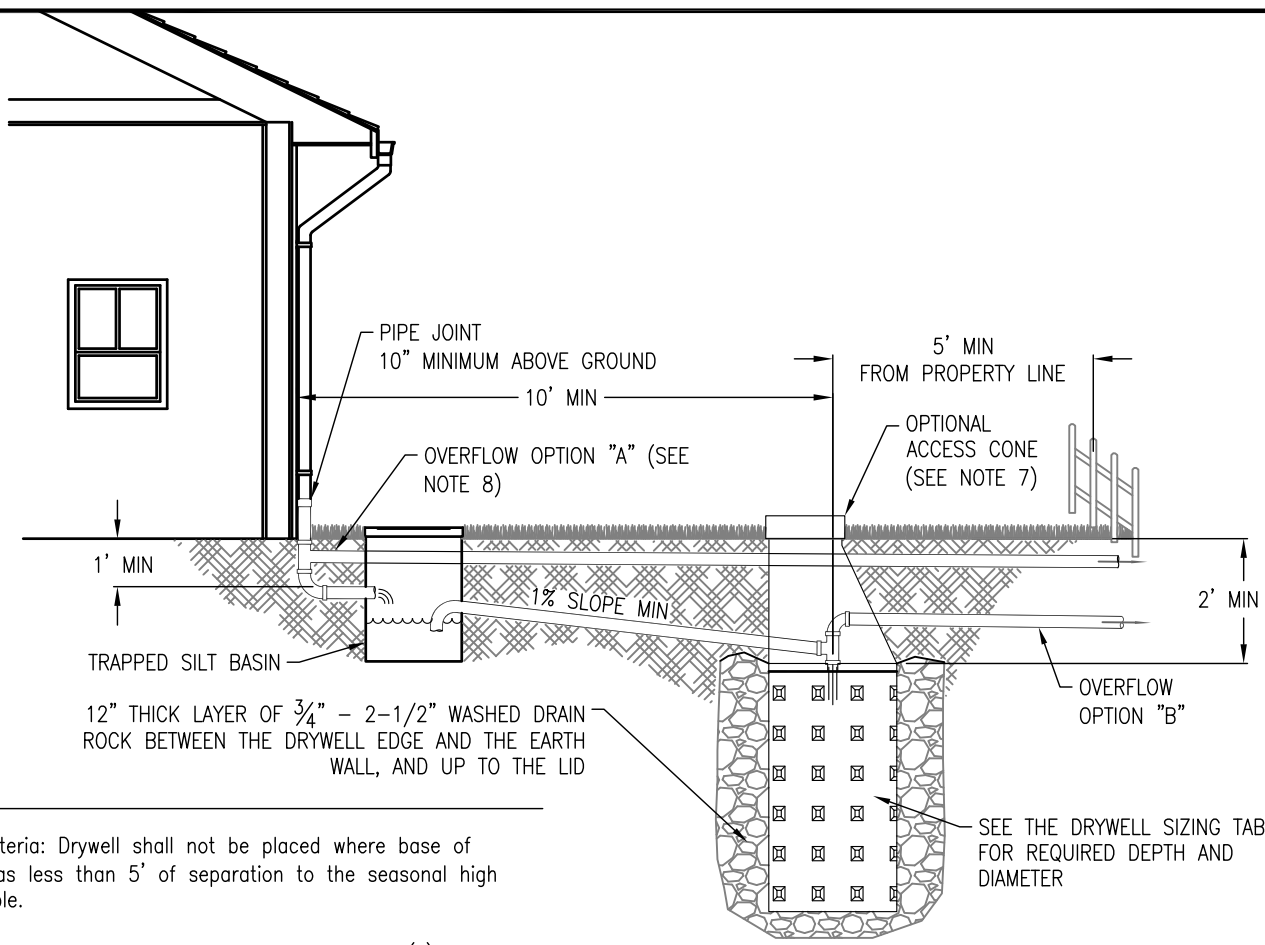

1. Siting Criteria: Drywell shall not be placed where base of facility has less than 5' of separation to the seasonal high water table.
2. Sizing: Use Drywell Sizing Table to size the drywell(s) based on impervious area.
3. Top of drywell must be below lowest finished floor.
4. Setbacks from center of drywell: Drywell must be 10' from foundations, 5' from property lines, and 20' from cesspools.
5. Piping must be cast iron, ABS or PVC. 3" pipe required for facilities draining up to 1500 sf, otherwise 4" minimum pipe. Oregon Plumbing Specialty Code also applies.
6. Silt Basin: Shall be included as pre-treatment for residential roofs. Silt basin shall be in accordance with design specifications for catch basin standards per Oregon Plumbing Specialty Code 1101.11.1-1101.11.5. Material may be plastic or metal. Lid must be solid.
7. Add maintenance access manhole and cone for drywell installed in non-residential settings. Access is optional in residential settings but highly recommended.
8. Overflow: Not required for sites with infiltration rates ≥ 2 "/hour. For areas with infiltration rates < 2 "/hour, install overflow pipe to approved discharge point. For flatter sites, option "A" may be used, where overflow is set 2"-6" higher than inlet to silt basin. For sloped sites, use overflow option "B" from top of drywell. Option "B" overflow pipe should be 4"-6" higher than pipe to drywell.

9. Drywells receiving flow from anything other than single-family residential roofs must be registered with DEQ as an Underground Injection Control (UIC).

Drywell Sizing Table

Once approval has been given by City of Gresham for onsite infiltration of stormwater, the following chart shall be used to select the number and size of drywells. Gray boxes are acceptable.

IMPERVIOUS Area (sq-ft)	28" Diameter			48" Diameter			
	10'	15'	20'	5'	10'	15'	20'
1000							
2000							
3000							
4000							
5000							
6000							
7000							
8000							
9000							
10000							

- DRAWING NOT TO SCALE - ORIGINAL DRAWING AND SPECIFICATIONS FROM PORTLAND BUREAU OF ENVIRONMENTAL SERVICES

CITY OF GRESHAM	DRYWELL	DRAWN DRO
		DATE OCT 2019
		APPR.
		DWG. NO. ST-170

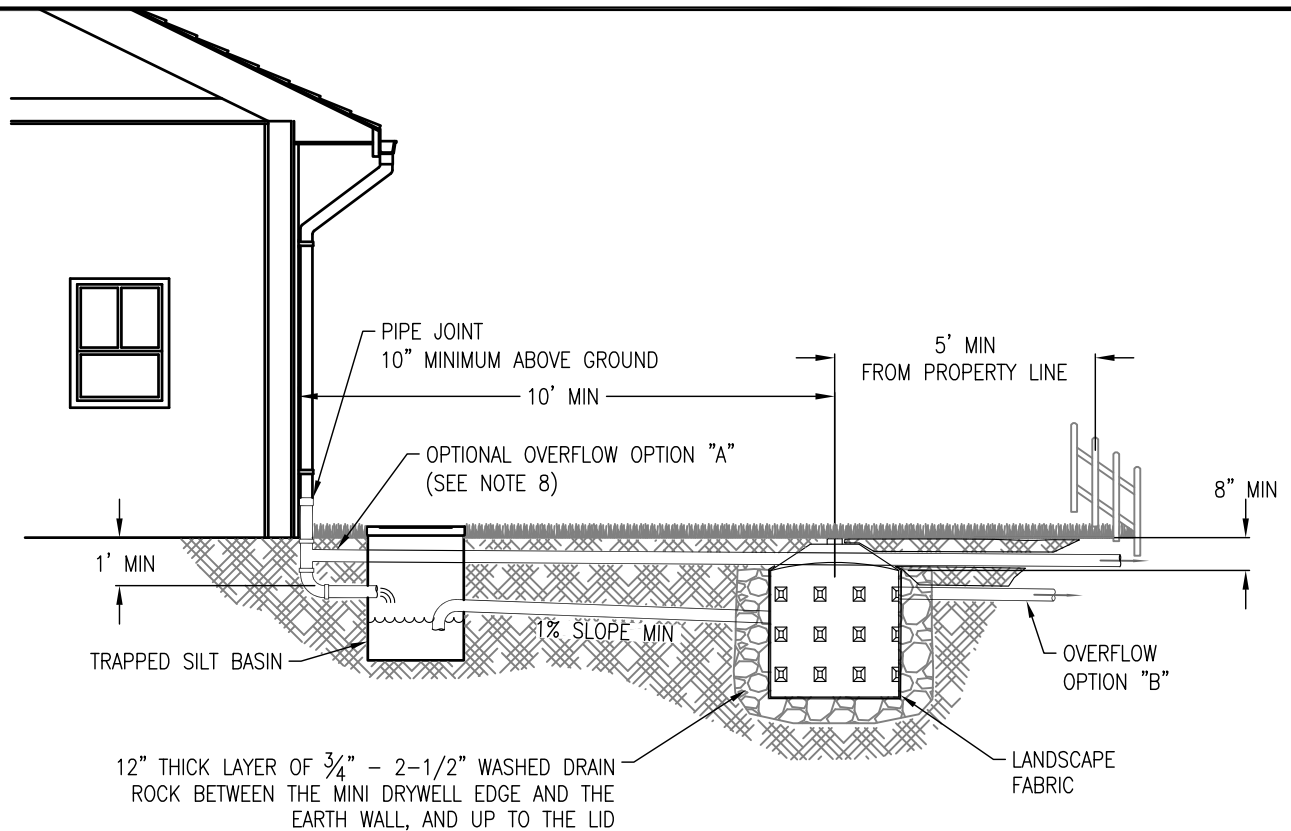

1. Siting Criteria: Mini drywell shall not be placed where base of facility has less than 5' of separation to the seasonal high water table.
2. Sizing: Only 500 sf of single family residential roof area may be connected to each mini drywell.
3. Top of mini drywell must be below lowest finished floor.
4. Wrap mini drywell with landscape fabric prior to backfilling with drain rock.
5. Setbacks from center of mini drywell: Mini drywell must be 10' from foundations, 5' from property lines, and 20' from cesspools.
6. Piping must be 3" cast iron, ABS or PVC. Oregon Plumbing Specialty Code also applies.
7. Silt Basin: Shall be included as pre-treatment for residential roofs. Silt basin shall be in accordance with design specifications for catch basin standards per Oregon Plumbing Specialty Code 1101.11.1-1101.11.5. Material may be plastic or metal. Lid must be solid.
8. Overflow: Not required for sites with infiltration rates ≥ 2 "/hour. For areas with infiltration rates < 2 "/hour, install overflow pipe to approved discharge point. For flatter sites, option "A" may be used, where overflow is set 2"-6" higher than inlet to silt basin. For sloped sites, use overflow option "B" from top of mini drywell. Option "B" overflow pipe should be 4"-6" higher than pipe to mini drywell.
9. Mini drywells for single-family residential roofs do not need to be registered with DEQ as an Underground Injection Control (UIC).

- DRAWING NOT TO SCALE -

ORIGINAL DRAWING AND SPECIFICATIONS FROM PORTLAND BUREAU OF ENVIRONMENTAL SERVICES

CITY OF
GRESHAM

MINI DRYWELL

DRAWN DRO

DATE OCT 2019

APPR.

DWG. NO. ST-171

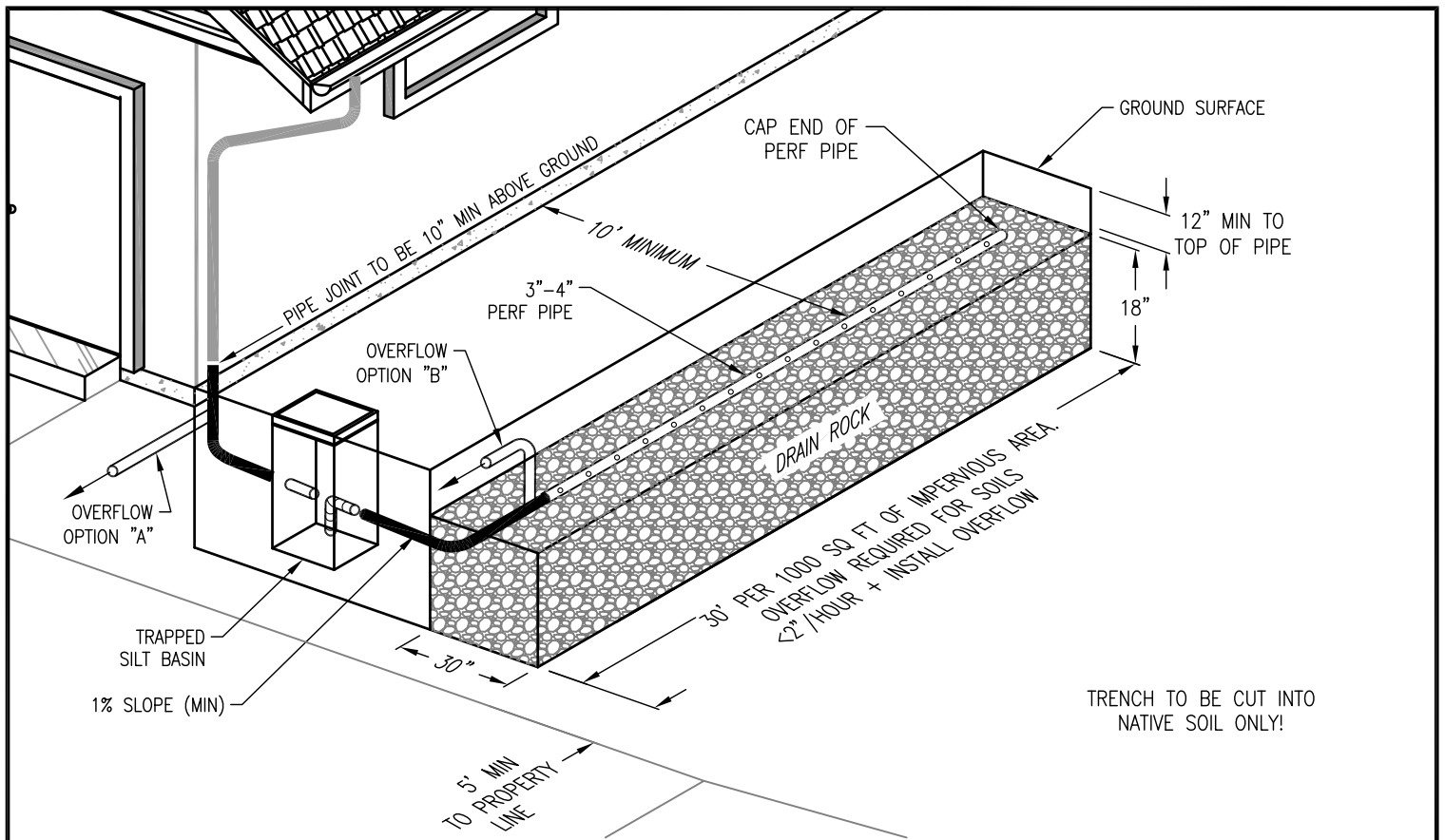

TRENCH TO BE CUT INTO NATIVE SOIL ONLY!

1. Provide protection from all vehicle traffic and equipment staging in proposed infiltration areas prior to, during and after construction.
2. Siting Criteria: Soakage trench shall not be placed where base of facility has less than 5' of separation to the seasonal high water table.
3. Sizing: 30" wide x 18" tall x 30' long per 1000 square feet of impervious surface.
4. Setbacks: Soakage trench must be 10' from foundations, 5' from property lines, and 20' from cesspools.
5. Piping must be cast iron, ABS or PVC. 3" pipe required for facilities draining up to 1500 sf, otherwise 4" minimum pipe. Oregon Plumbing Specialty Code also applies.
6. Silt Basin: Shall be included as pre-treatment for residential roofs. Silt basin shall be in accordance with design specifications for catch basin standards per Oregon Plumbing Specialty Code 1101.11.1-1101.11.5. Material may be plastic or metal. Lid must be solid.
7. Overflow: Not required for sites with infiltration rates ≥ 2 "/hour. For areas with infiltration rates < 2 "/hour, install overflow pipe to approved discharge point. For flatter sites, option "A" may be used, where overflow is set 2"-6" higher than inlet to silt basin. For sloped sites, use option "B" with Tee that is 4"-6" higher than pipe in trench.
8. Soakage trenches receiving flow from anything other than single-family residential roof runoff must be registered with DEQ as a (UIC).

SOAKAGE TRENCH CONSTRUCTION

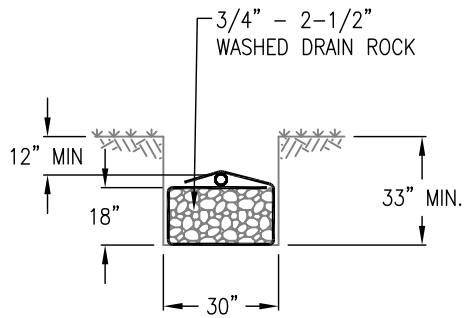

FILTER FABRIC TO BE PLACED ON SIDES AND ENDS OF TRENCH. ADD DRAIN ROCK AND FOLD ONE SIDE OF FABRIC OVER ROCK. PLACE PERFORATED PIPE IN CENTER AND THEN INSTALL GREEN TRACER WIRE ON PIPE. COVER ALL WITH REMAINING SIDE OF FABRIC PRIOR TO BACKFILL.

- DRAWING NOT TO SCALE - ORIGINAL DRAWING AND SPECIFICATIONS FROM PORTLAND BUREAU OF ENVIRONMENTAL SERVICES

CITY OF GRESHAM	SOAKAGE TRENCH	DRAWN DRO
		DATE OCT 2019
		APPR.
		DWG. NO. ST-180

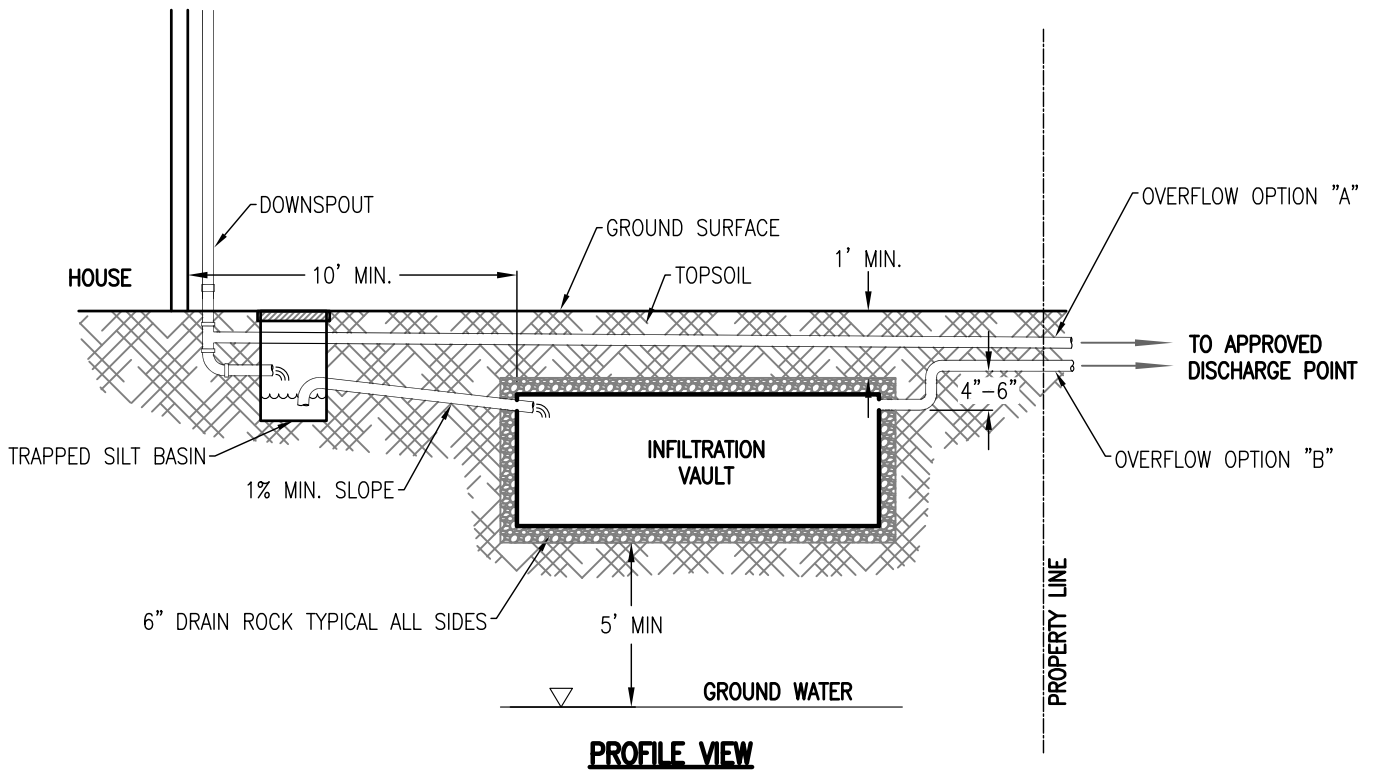

PROFILE VIEW

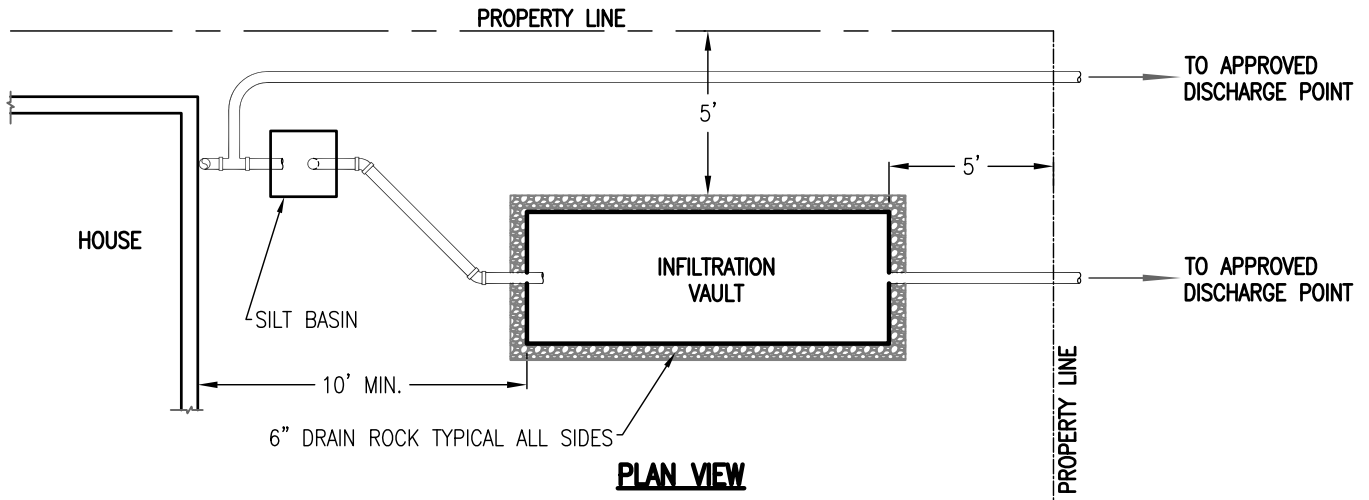

PLAN VIEW

1. Silt basin shall be included as pre-treatment for all residential roofs. Silt basin shall be W12" x L12" with depth that allows for 6"-12" of sedimentation.
2. Infiltration vaults receiving flow from anything other than single-family residential roofs must be registered with DEQ as an underground injection control device.
3. Overflow: Not required for sites with soil infiltration rates ≥ 2 "/hour. For areas with infiltration rates < 2 "/hour, install overflow pipe to approved discharge point. For flatter sites, use overflow option "A", where overflow is set 2"-6" higher than inlet to silt basin. For sloped sites, use option "B", where overflow leaves vault with a 4"-6" upturn.
4. Setbacks: 5' from property lines and 10' from foundations.

- DRAWING NOT TO SCALE -

<p>CITY OF GRESHAM</p>	<p>INFILTRATION VAULT</p>	<p>DRAWN RMS</p>
		<p>DATE JUNE 2018</p>
		<p>APPR.</p>
		<p>DWG. NO. ST-190</p>